

Platinum Metal Skin



Functional Specifications

RF air protocol	EPC Class 1 Gen 2; ISO 18000-6C
Operating frequency	902-928 MHz (US), 865-868 MHz (EU)
IC type	Alien higgs4
Memory configuration	128 bits user memory, 128 bits EPC, 96 bits TID
Functionality	Read / write (user programmed)
Memory – expected read / write cycles	10,000 cycles at 77°F (25°C)
Data retention	Up to 10 years

Performance Characteristics

Read range on metal (2W ERP)*	Up to 6.6 ft (1.5 m)
Read range off metal (2W ERP)*	Up to 3.9 ft (1.2 m)
Read range on liquid (2W ERP)*	Up to 3.9 ft (1.2 m)
Polarization	Linear

Smart Label Specifications

Dimensions / tolerance (mm)	58 (+/- 0.5) x 19 (+/- 0.5) x 0.8 (+/- 0.1)
Dimensions / tolerance (in)	2.28 (+/- 0.02) x 0.75 (+/- 0.02) x 0.03 (+/- 0.004)
Pitch on reel	1.38 in (34.93 mm)
Quantity per reel	1000
Inner reel core diameter	3 in (76.2 mm)
Outer reel diameter	6 in (153 mm)
Weight (piece)	0.053 oz (1.5 g)
Weight (reel)	3.53 lbs (1.6 kg)



*Actual read range may vary based upon use case and antenna power.

Product Dimensions



Product Reel Dimensions

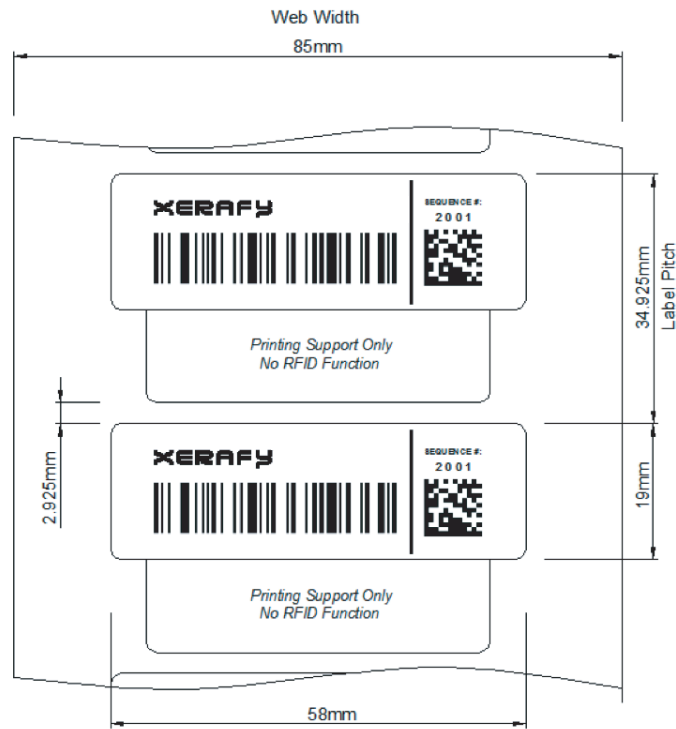

Smart Label Cross Section

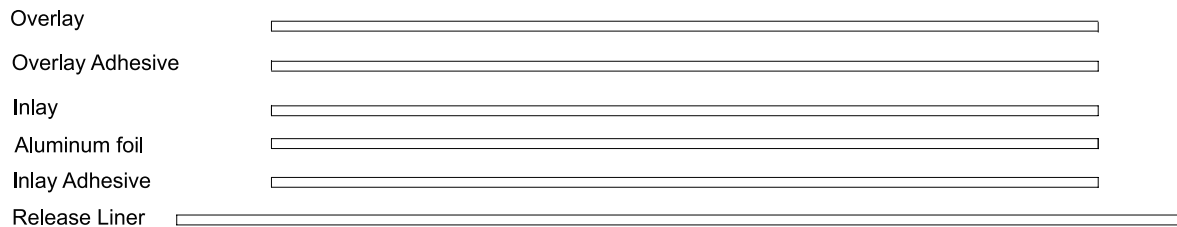

Radiation Pattern

On metal

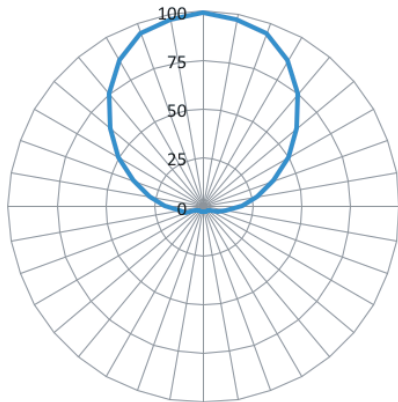

Horizontal

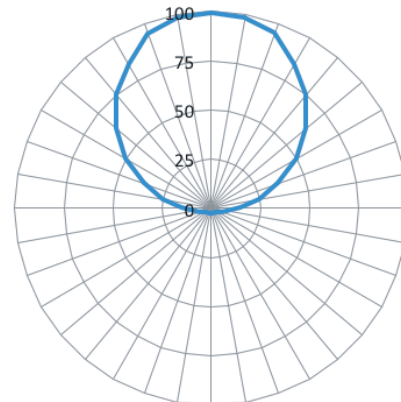

Vertical

Off metal

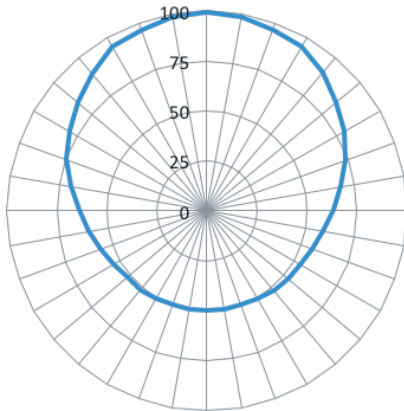

Horizontal

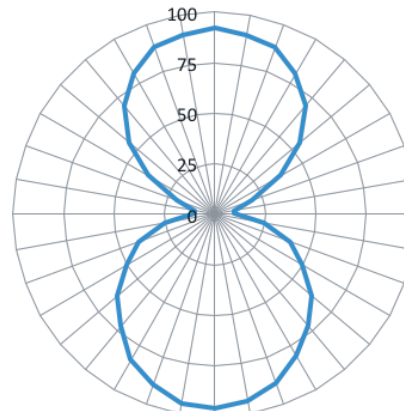

Vertical

On Liquid

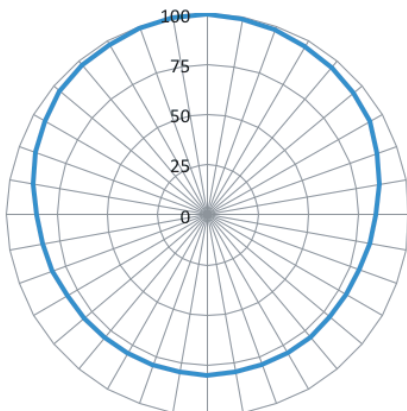

Horizontal

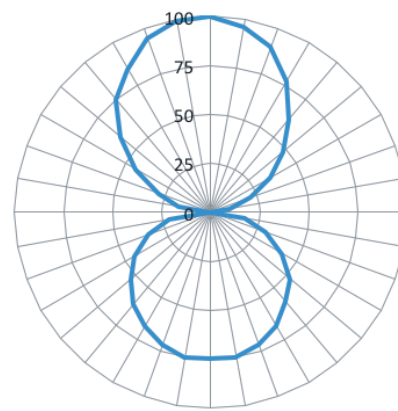

Vertical

Operational and Environmental Specifications

Operational temperature	
Cold	-40°F (-40°C)
Dry heat	+185°F (+85°C)
Thermal shock	-40°F to 185°F (-40°C to +85°C); cycled
Application temperature	
Cold	-40°F (-40°C)
Dry heat	+185°F (+85°C)
Storage conditions	1 years at +68°F (+20°C) and 50% relative humidity
Shock (drop)	3 ft (1 m) to concrete/granite up to 200 cycles
Compression strength	14 psi (97 kPa)
Compliance	RoHS, CE

Application Instructions

Tag performance when attached on curve surface:

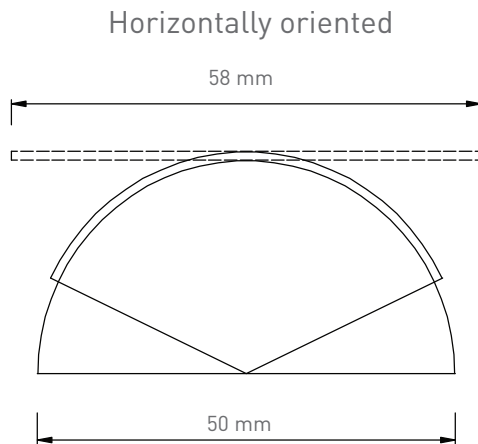

Read range on metal

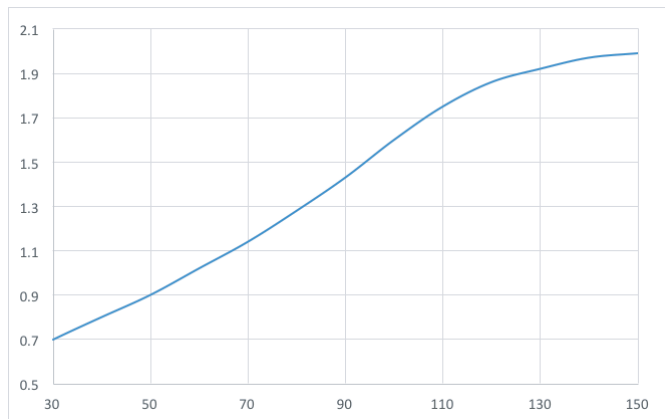

Read range off metal

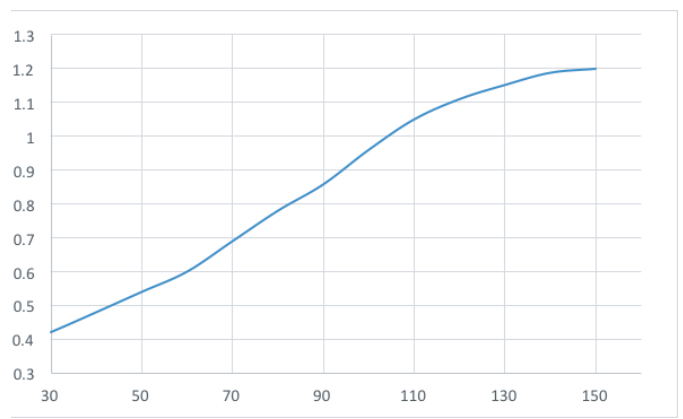

X: Diameter/mm Y: Read Range/ m



Personalization options

Several options are available:

- Pre-encoding - Customer specific encoding of EPC or user memory.
- Customized printing - Customer specific layout including logo, text, numbers, barcodes etc.

Printer Compatibility

SATO	CL4NX
TOSHIBA	B-SX4T/XS5T

Order information

X50A1-US100-H4	Platinum Metal Skin Label in Roll US
X50A1-EU100-H4	Platinum Metal Skin Label in Roll EU